

HOMEDICS®

LEADERS IN HEALTH & WELLBEING

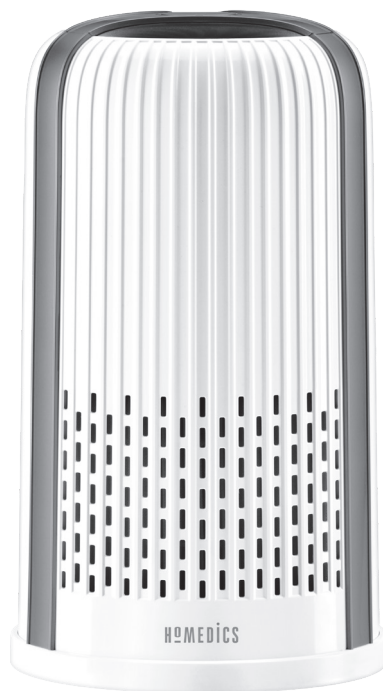

Register your product today at
www.homedics.co.uk/product-registration



TOTALCLEAN® 4IN1AIRPURIFIER

instruction manual

AP-T10-GB

2 YEAR GUARANTEE

**READ ALL INSTRUCTIONS BEFORE USE.
SAVE THESE INSTRUCTIONS FOR FUTURE
REFERENCE.**

- ALWAYS unplug the appliance from the electrical outlet immediately after using and before cleaning. To disconnect, turn all controls to the 'OFF' position, then remove plug from outlet.
- Unplug from the mains outlet when not in use and before putting on or taking off parts or attachments.
- This appliance can be used by children aged from 8 years and above and persons with reduced physical, sensory or mental capabilities or lack of experience and knowledge if they have been given supervision or instruction concerning use of the appliance in a safe way and understand the hazards involved. Children shall not play with the appliance. Cleaning and user maintenance shall not be made by children without supervision.
- DO NOT reach for an appliance that has fallen in water or other liquids. Switch off at the mains and unplug it immediately. Keep dry – DO NOT operate in wet or moist conditions.
- NEVER insert pins or other metallic fasteners into the appliance.
- Use this appliance for the intended use as described in this booklet. DO NOT use attachments not recommended by HoMedics.
- NEVER operate the appliance if it has a damaged cord or plug, if it is not working properly, if it has been dropped or damaged, or dropped into water. Return it to the HoMedics Service Centre for examination and repair.
- Keep cord away from heated surfaces.
- Excessive use could lead to the product's excessive heating and shorter life. Should this occur, discontinue use and allow the unit to cool before operating.
- NEVER drop or insert any object into any opening.
- DO NOT operate where aerosol (spray) products are being used or where oxygen is being administered.
- DO NOT operate under a blanket or pillow. Excessive heating can occur and cause fire, electrocution or injury to persons.
- DO NOT carry this appliance by the cord or use cord as a handle.
- DO NOT use outdoors.
- This product requires a 220-240 V AC power supply.
- DO NOT attempt to repair the appliance. There are no user serviceable parts. For service, send to a HoMedics Service Centre. All servicing of this appliance must be performed by authorised HoMedics service personnel only.
- Never block the air openings of the appliance or place it on a soft surface, such as a bed or couch. Keep air openings free of lint, hair etc.
- Do not place or store appliance where it can fall or be pulled into a bath or sink. Do not place in or drop into water or other liquid.
- Failure to follow the above may result in the risk of fire or injury.
- This appliance should NEVER be used by any individual suffering from any physical ailment that would limit the user's capacity to operate the controls.
- If the product feels excessively hot, switch off at mains and contact the HoMedics Service Centre.

- Do not run cord under carpeting. Do not cover cord with throw rugs, runners or similar coverings. Do not route cord under furniture or appliances. Arrange cord away from traffic areas where it can be tripped over.

TWO YEAR GUARANTEE

FKA Brands Ltd guarantees this product from defect in material and workmanship for a period of 2 years from the date of purchase, except as noted below. This FKA Brands Ltd product guarantee does not cover damage caused by misuse or abuse; accident; the attachment of any unauthorised accessory; alteration to the product; or any other conditions whatsoever that are beyond the control of FKA Brands Ltd. This guarantee is effective only if the product is purchased and operated in the UK / EU. A product that requires modification or adaptation to enable it to operate in any country other than the country for which it was designed, manufactured, approved and / or authorised, or repair of products damaged by these modifications is not covered under this guarantee. FKA Brands Ltd shall not be responsible for any type of incidental, consequential or special damages.

To obtain guarantee service on your product, return the product post-paid to your local service centre along with your dated sales receipt (as proof of purchase). Upon receipt, FKA Brands Ltd will repair or replace, as appropriate, your product and return it to you, post-paid. Guarantee is solely through HoMedics Service Centre. Service of this product by anyone other than the HoMedics Service Centre voids the guarantee. This guarantee does not affect your statutory rights.

For your local HoMedics Service Centre, go to www.homedics.co.uk/servicecentres

WEEE explanation

 This marking indicates that this product should not be disposed with other household wastes throughout the EU. To prevent possible harm to the environment or human health from uncontrolled waste disposal, recycle it responsibly to promote the sustainable reuse of material resources. To return your used device, please use the return and collection systems or contact the retailer where the product was purchased. They can take this product for environmental safe recycling.

PRODUCT FEATURES

CONTROL PANEL

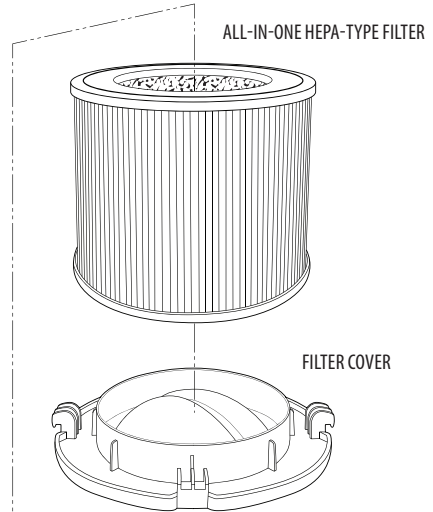
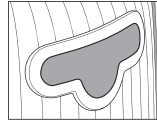
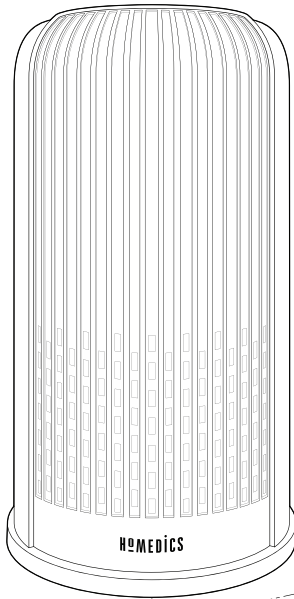
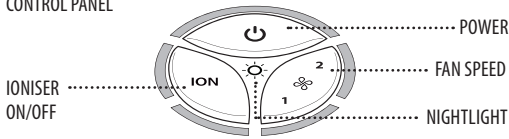

ALL-IN-ONE HEPA-TYPE FILTRATION SYSTEM

HEPA-TYPE FILTRATION

Removes up to 99% of airborne particles as small as 0.3 microns, such as allergens, pollen, dust, germs, pet dander, odour, mould spores, and smoke from air that passes through the filter.

CARBON ODOUR FILTRATION

Reduces household odours and VOCs (volatile organic compounds)/gases as shown by independent laboratory testing.

PRE-FILTER

Captures large particles.

IONISER WITH ON/OFF

When on, the ioniser assists in the air purification process.

2 SPEEDS

Low and high.

REPLACE FILTER INDICATOR

Illuminates when it is time to replace the filter.

SUGGESTED ROOM SIZE

40M²/H / 427FT²/H. Portable air purifiers will be more effective in rooms where all the doors and windows are closed.

AIR CHANGES PER HOUR

This air purifier will purify the air in a 40M² / 427 FT² room (assuming an 2.43 M/8 FT ceiling) once per hour on high speed in a closed room. The airflow rate is 97M³/H / 3418 FT³/H.

OIL TRAY



Includes 3 essential oil pads. Use with essential oil (not included) to deliver scent into the air.

OPERATING INSTRUCTIONS

BEFORE TURNING THE UNIT ON

- Take the air purifier out of the box and remove the clear protective plastic bag.
- Place the air purifier on a firm, level surface.
- Plug the power cord into a standard AC outlet.

POWER BUTTON AND FAN SPEED SETTINGS

- To turn the air purifier on, press the power  button.
- This air purifier has 2 fan speed settings: low and high. The higher the fan speed setting, the faster the air will be purified. To select or change fan speed, press the fan speed  button until the desired setting is reached.

IONISER SETTING WITH ON/OFF

Ion particles have a positive or negative charge that attach to airborne particles, making them easier to be captured by the filtration system. Press the ioniser **ION** button to turn the ioniser on. The blue light will glow to indicate the ioniser is in use. Press the ioniser **ION** button again to turn the ioniser off.

NOTE: Dust particles may accumulate on surfaces around the air purifier when the ioniser is in use. These dust particles can be vacuumed or wiped away with a soft, damp cloth.

NOTE: You may hear occasional popping sounds when the ioniser is used. This is normal.

NOTE: The ioniser produces less ozone than the UL-established limits of 0.05 ppm. Ozone may be harmful around birds and small pets. To prevent ozone buildup, use the ioniser feature in a well-ventilated area.

NIGHTLIGHT

The nightlight has 3 options. Press the nightlight  button once to turn the blue nightlight on. Press again to turn the blue nightlight ring and the display lights off. Press a third time to turn the display lights on.

OIL TRAY

Use essential oil (not included) to deliver scent into the air.

NOTE: For use with the included HoMedics essential oil pads only. Do not add essential oils anywhere else in the unit as it may cause damage.

NOTE: Do not leave a filled essential oil pad in the air purifier if it will be out of use for a long period of time.

ARE ESSENTIAL OILS SAFE TO USE AROUND PETS?

We should always exercise caution when using essential oils around our pets. Keep all essential oil and aromatherapy products (like diffusers) out of reach of pets. Keep open bottles away from pets to avoid internal consumption. We do not recommend the topical use of essential oils on pets, as they have a strong sense of smell and cannot get rid of the oil if they don't like it or it is disturbing them. When diffusing essential oils around pets, always diffuse in a well-ventilated area and leave an option for them to remove themselves from the space, such as leaving a door open. Every animal is different, so carefully observe how each animal responds when introducing an essential oil for the first time. If irritation occurs, discontinue the use of the essential oil. We recommend seeking medical attention if ingestion of essential oil occurs.

ADDING ESSENTIAL OILS

This air purifier has been certified by the European Centre for Allergy Research Foundation (ECARF) as an allergy-friendly product. Please note that allergy friendliness is no longer guaranteed if the Essential Oil Scent Tray function is used, since essential oils may lead to allergic reactions.

WARNING: Putting oil anywhere but the oil tray will damage the air purifier.

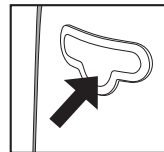

1. The oil tray is located on the side of the air purifier.

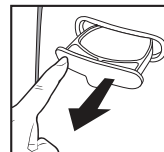

2. Push to open and remove the tray.

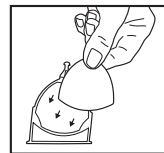

3. Place 1 aroma pad (3 included) into the oil tray.

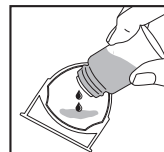

4. Add 5–7 drops of essential oil to the pad. You may use more or less depending on personal preference.

WARNING: Only place essential oil on the pad and NOT directly into the tray.

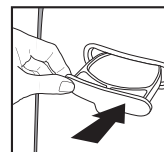

5. Place the oil tray back in its compartment and push to close. The scent will start automatically when the air purifier is turned on.

FILTER REPLACEMENT

REPLACE FILTER LIGHT

The replace filter light illuminates when it is time to replace the HEPA-type filter based on the air purifier's hours of use.

REPLACING THE HEPA-TYPE FILTER

For optimal performance, replace every 12 months under normal usage conditions.

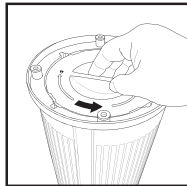

1. Unplug the air purifier and turn upside down. Turn the filter cover as indicated to remove.

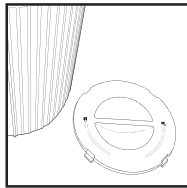

2. Remove the filter cover and set aside.

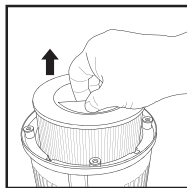

3. Pull to remove the old filter

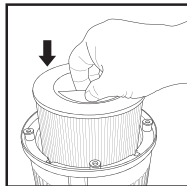

4. Slide the new HEPA-type filter into the filter cavity.



5. Reinstall the filter cover and turn to the right to lock in place.

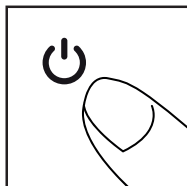

6. Plug the power cord into a standard AC outlet. Turn the air purifier on. Press and hold the power button for 3 seconds to reset the indicator.

CLEANING & MAINTENANCE

CLEANING THE PRE-FILTER

NOTE: For best performance, vacuum the pre-filter once a month under normal usage.

1. Unplug the air purifier.
2. Remove the HEPA-type filter as described in the Replacing the HEPA-type Filter section.
3. Vacuum the outside of the HEPA-type filter using the brush attachment of your vacuum cleaner, cleaning it thoroughly.
4. Place the HEPA-type filter back into the air purifier and close grille.
5. Plug the power cord into a standard AC outlet.

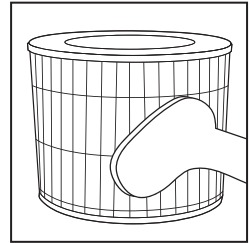

TO CLEAN THE OIL TRAY

Open the oil tray and remove the pad. Essential oil pads should be changed when switching to a different essential oil scent. If continuing to use the same scent, set the essential oil pad aside for reuse. Wipe down the inside of the oil tray with a soft cloth. Place the essential oil pad back in the tray and close.

NOTE: Leave the essential oil pad out of the oil tray when storing.

WARNING: The appliance is only to be used with the recommended vaporising medium. The use of other substances may give rise to a toxic or fire risk.

FOR BEST PERFORMANCE

- NEVER use water or any household cleaners or detergents to clean the HEPA-type filter.
- Clean off the outside of the unit with a dry cloth as needed.
- NEVER use water, wax, polish, or any chemical solution to clean the outside of the unit.
- Clean off the grille cover using a damp cloth or the brush attachment of your vacuum as needed.
- Vacuum the pre-filter monthly under normal usage conditions.
- Replace the HEPA-type filter every 12 months under normal usage conditions.
- Always use a genuine HoMedics replacement filter for optimal performance.

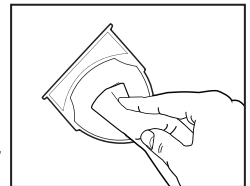

To purchase genuine HoMedics replacement/spare parts please visit www.homedics.co.uk

3 Pack of aroma pads - ARM-PAD3

Aroma tray - AP-T10WTARM

HEPA filter - AP-T10FLR

TROUBLESHOOTING

PROBLEM	POSSIBLE CAUSE	SOLUTION
Unit will not operate	<ul style="list-style-type: none">• Unit is not plugged in• Power button not pressed• No power to unit• HEPA-type filter is not installed correctly• Grille cover is not installed correctly	<ul style="list-style-type: none">• Plug unit in• Press the power button to turn the power on• Check fuses, try a different outlet• Reinstall the HEPA-type filter• Reinstall the grille cover
Reduced airflow	<ul style="list-style-type: none">• The back grille may be blocked• Pre-filter needs vacuuming• The HEPA-type filter needs to be replaced	<ul style="list-style-type: none">• Check to make sure nothing is blocking the back grille and air outlet• Vacuum the pre-filter with the brush attachment of your vacuum cleaner• Replace the HEPA-type filter
Reduced odour removal	<ul style="list-style-type: none">• The HEPA-type filter needs to be replaced	<ul style="list-style-type: none">• Replace the HEPA-type filter
Excessive noise	<ul style="list-style-type: none">• The unit is not level	<ul style="list-style-type: none">• Place the unit on a flat, level surface
Replace filter light remains lit after filter replacement	<ul style="list-style-type: none">• The replace filter indicator needs to be reset	<ul style="list-style-type: none">• Press and hold the ioniser button for 3 seconds until the replace filter light turns off
Display lights are off	<ul style="list-style-type: none">• Nightlight setting	<ul style="list-style-type: none">• Press the nightlight button until the desired lights are on/off



Manufacturer & UK Importer: FKA Brands Ltd, Somerhill Business Park, Tonbridge, Kent TN11 0GP, UK
EU Importer: FKA Brands Ltd, 29 Earlsfort Terrace, Dublin 2, Ireland
Distributor in Australia: HoMedics Australia Pty Ltd, 14 Kingsley Close, Rowville, VIC 3178, Australia
Customer Support: +44(0) 1732 378557 | support@homedics.co.uk

IB-APT10GB-1220-01